

MISCELLANEOUS

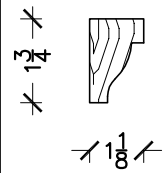

MSC-001

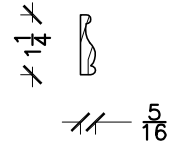

MSC-002

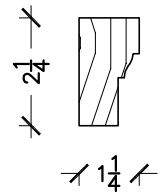

MSC-003

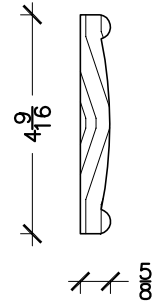

MSC-004

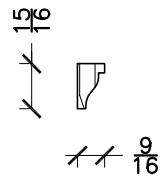

MSC-005

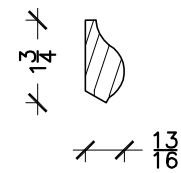

MSC-006

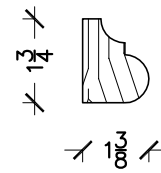

MSC-007

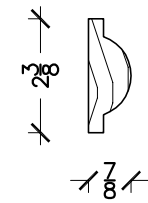

MSC-008

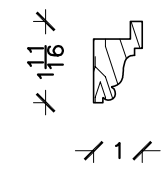

MSC-009

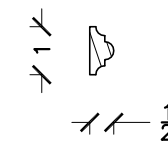

MSC-010

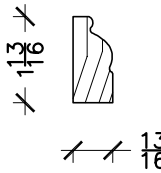

MSC-011

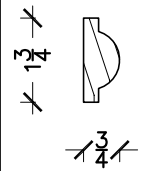

MSC-012

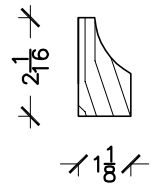

MSC-013

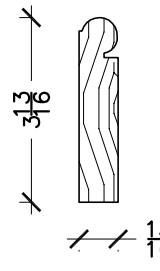

MSC-014

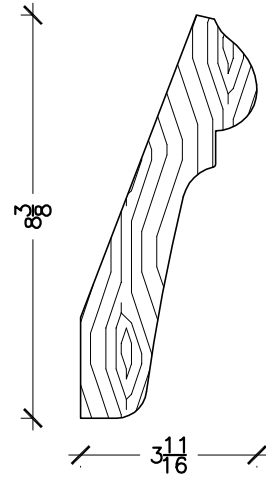

MSC-015

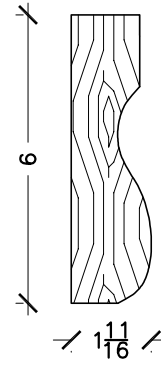

MSC-016

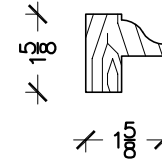

MSC-017

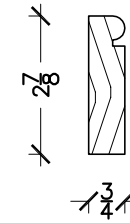

MSC-018

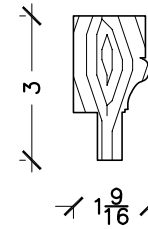

MSC-019

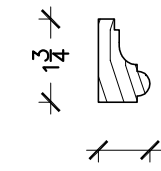

MSC-020

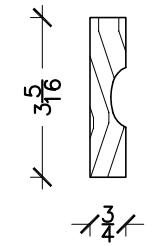

MSC-021

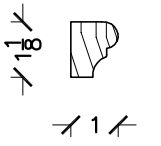

MSC-021

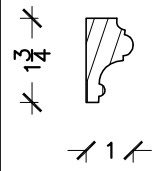

MSC-023

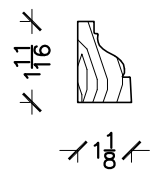

MSC-024

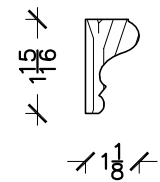

MSC-025

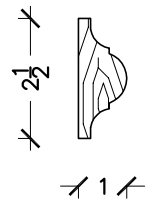

MSC-026

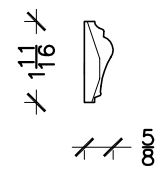

MSC-027

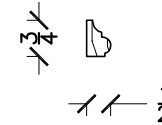

MSC-028

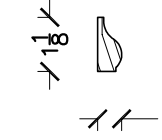

MSC-029



MSC-030

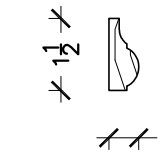

MSC-031

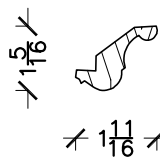

MSC-032

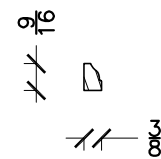

MSC-033

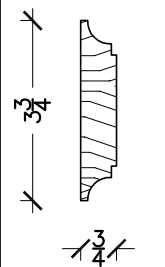

MSC-034

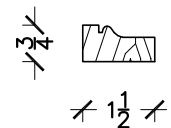

MSC-035

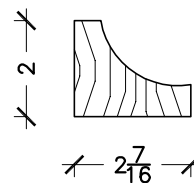

MSC-036

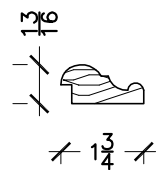

MSC-038

TRIM PROFILES

DATE 00/00/00	SCALE 3" = 1'-0"	DRAWN BY WW
------------------	---------------------	----------------

K & L WOODWORKING, INC.
440 N. 4TH STREET READING, PA 19601

SHEET DESCRIPTION TRIM PROFILES	SHEET NO. CS-1
------------------------------------	-------------------

CASING

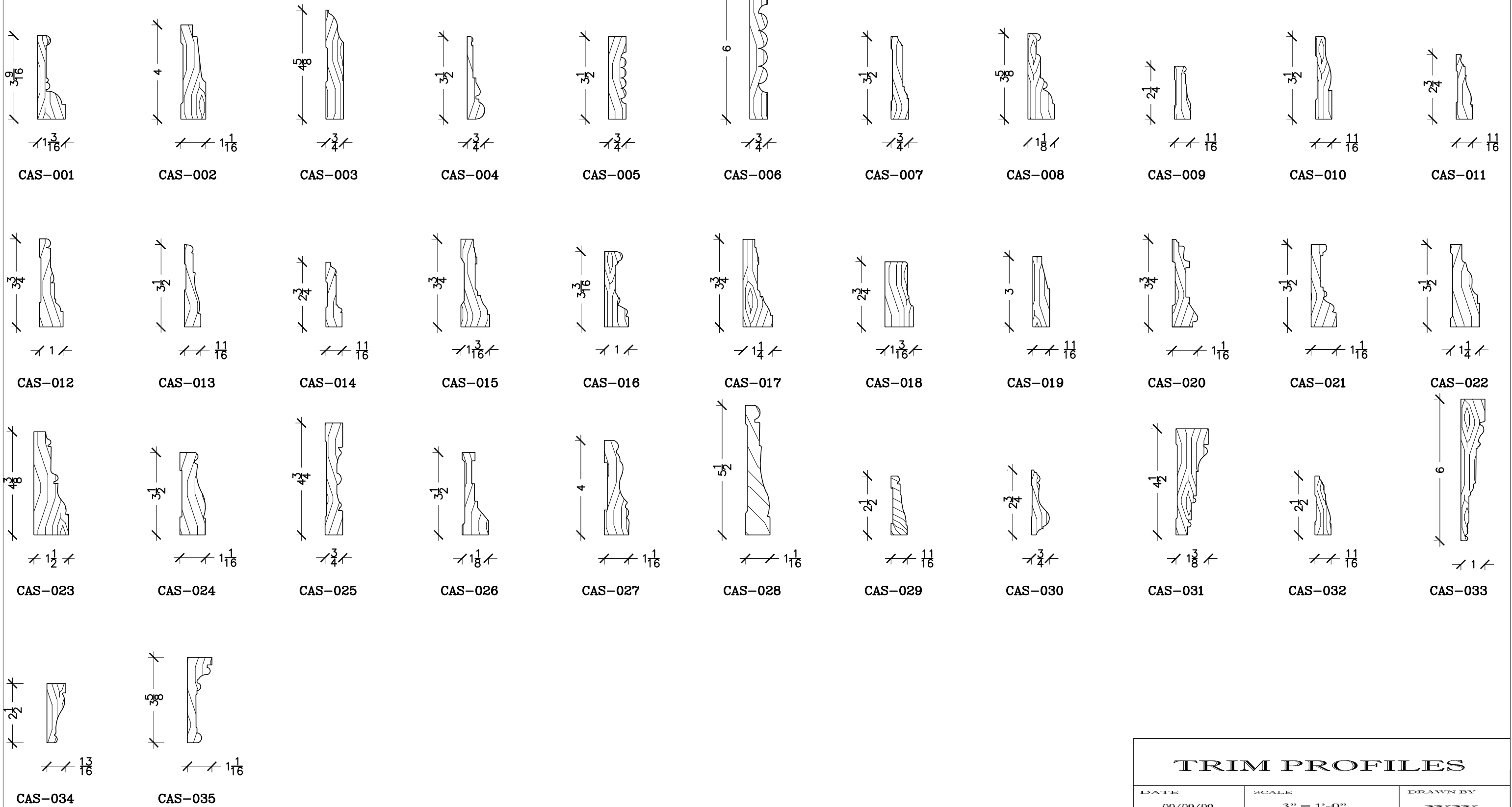

TRIM PROFILES

DATE 00/00/00	SCALE 3" = 1'-0"	DRAWN BY WW
------------------	---------------------	----------------

K & L WOODWORKING, INC.
440 N. 4TH STREET READING, PA 19601

SHEET DESCRIPTION
TRIM PROFILES

SHEET NO.
CS-2

CROWN

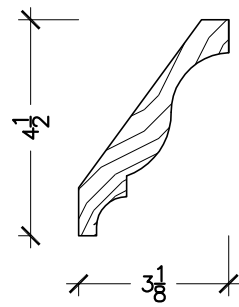

CRN-001

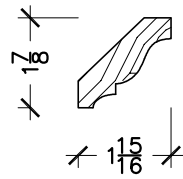

CRN-002

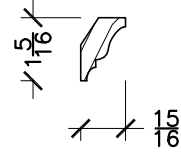

CRN-003

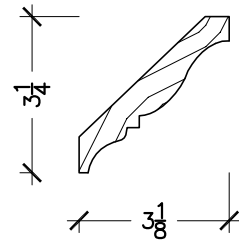

CRN-004

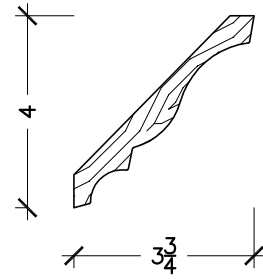

CRN-005

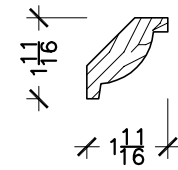

CRN-006

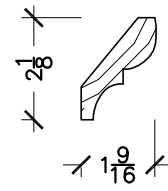

CRN-007

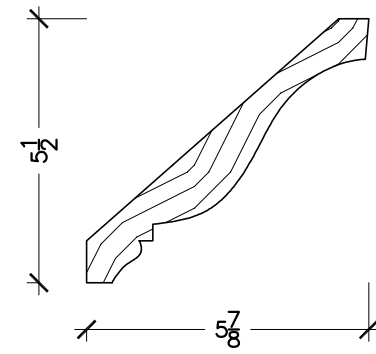

CRN-008

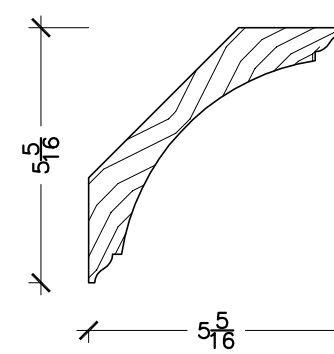

CRN-009

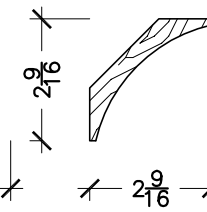

CRN-010

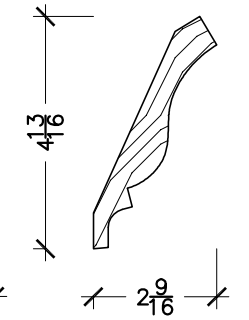

CRN-011

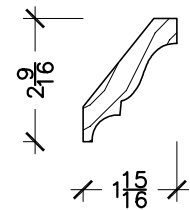

CRN-012

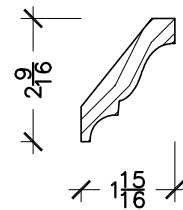

CRN-013

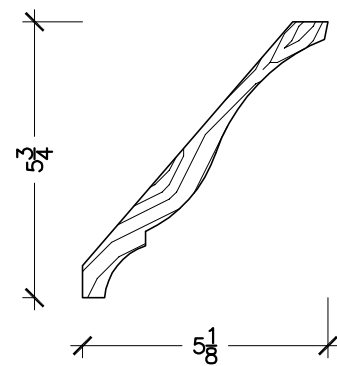

CRN-014

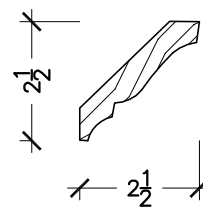

CRN-015

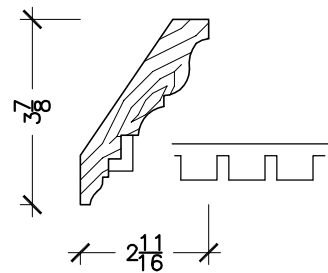

CRN-016

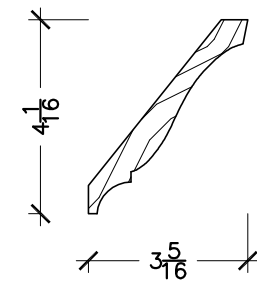

CRN-017

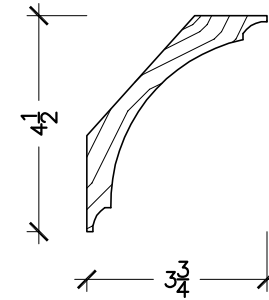

CRN-018

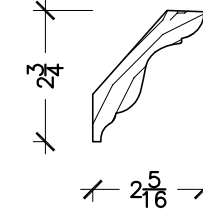

CRN-019

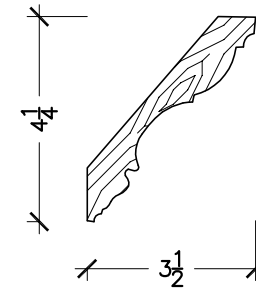

CRN-020

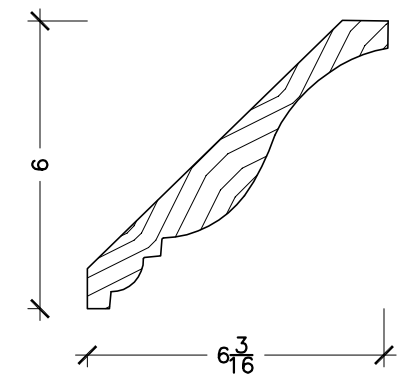

CRN-021

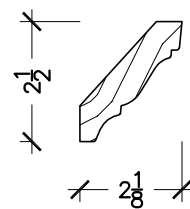

CRN-022

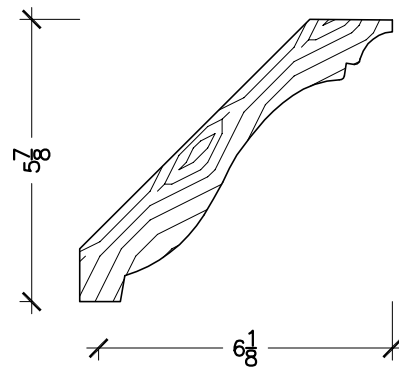

CRN-023

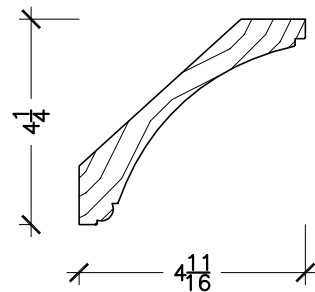

CRN-024

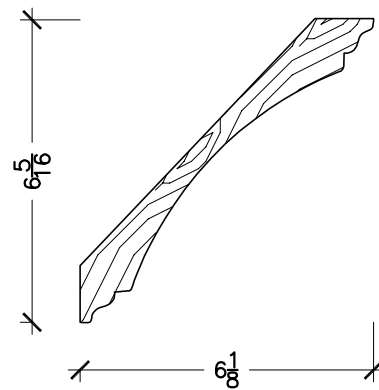

CRN-025

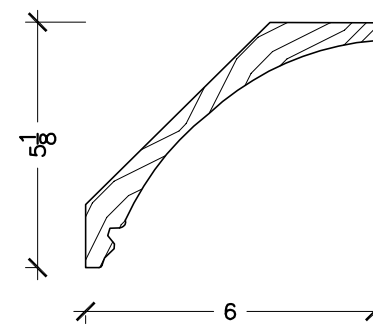

CRN-026

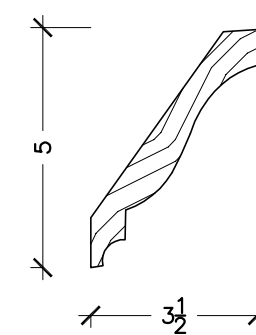

CRN-027

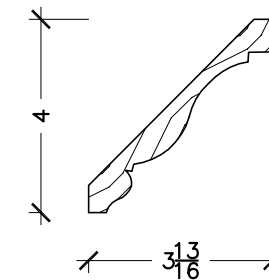

CRN-028

TRIM PROFILES

DATE 00/00/00	SCALE 3" = 1'-0"	DRAWN BY WW
------------------	---------------------	----------------

K & L WOODWORKING, INC.
440 N. 4TH STREET READING, PA 19601

SHEET DESCRIPTION TRIM PROFILES	SHEET NO. CS-3
------------------------------------	-------------------

CROWN

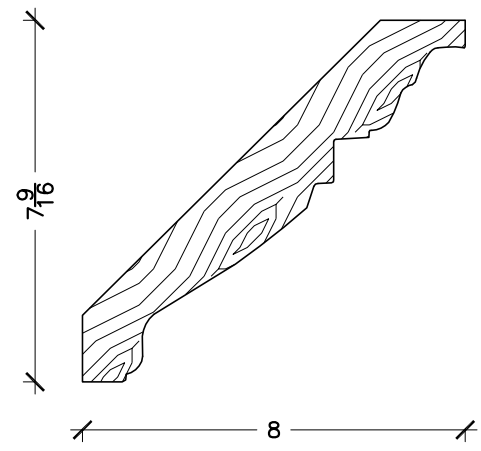

CRN-029

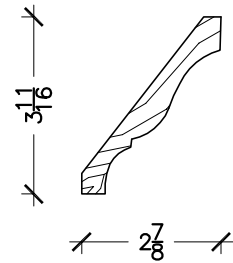

CRN-030

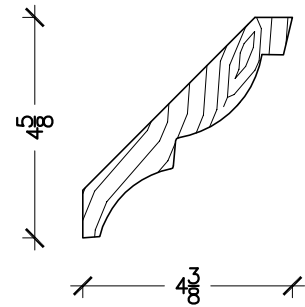

CRN-031

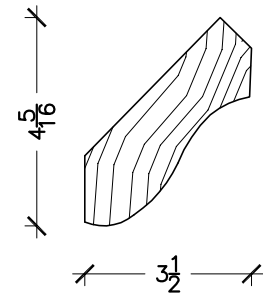

CRN-032

TRIM PROFILES

DATE 00/00/00	SCALE 3" = 1'-0"	DRAWN BY WW
------------------	---------------------	----------------

K & L WOODWORKING, INC.
440 N. 4TH STREET READING, PA 19601

SHEET DESCRIPTION TRIM PROFILES	SHEET NO. CS-3b
------------------------------------	--------------------

CHAIR RAIL

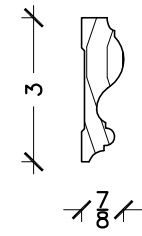

CHR-001

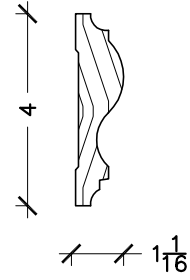

CHR-002

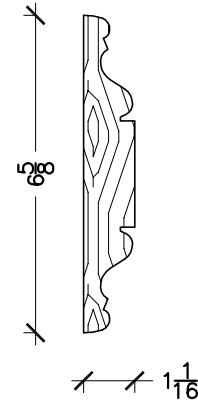

CHR-003

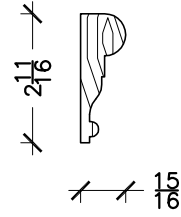

CHR-004

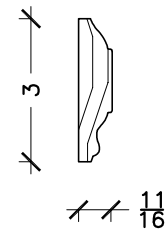

CHR-005

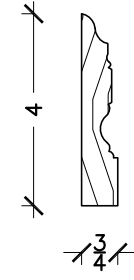

CHR-006

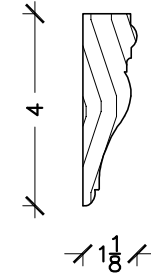

CHR-007

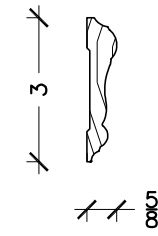

CHR-008

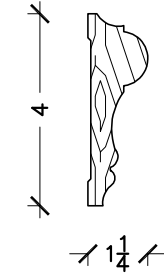

CHR-009

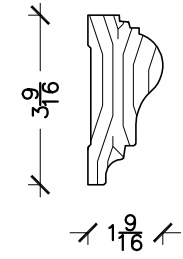

CHR-010

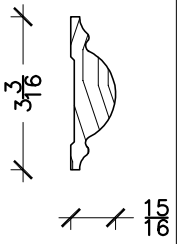

CHR-011

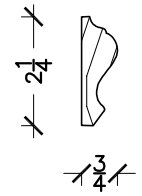

CHR-012

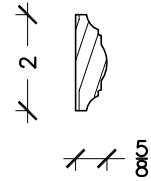

CHR-013

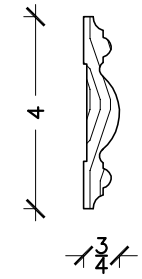

CHR-014

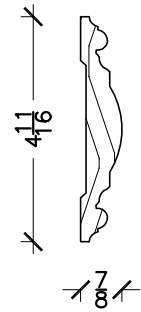

CHR-015

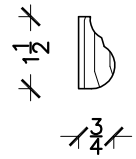

CHR-016

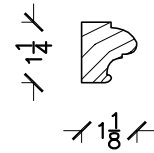

CHR-017

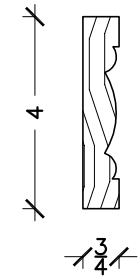

CHR-018

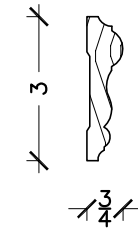

CHR-019

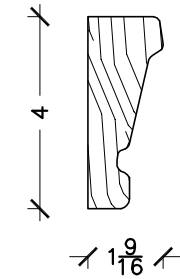

CHR-020

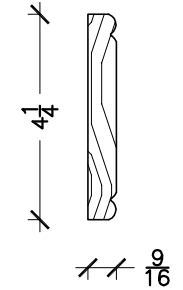

CHR-021

TRIM PROFILES

DATE 00/00/00	SCALE 3" = 1'-0"	DRAWN BY WW
------------------	---------------------	----------------

K & L WOODWORKING, INC.
440 N. 4TH STREET READING, PA 19601

SHEET DESCRIPTION TRIM PROFILES	SHEET NO. CS-4
------------------------------------	-------------------

BASE CAP

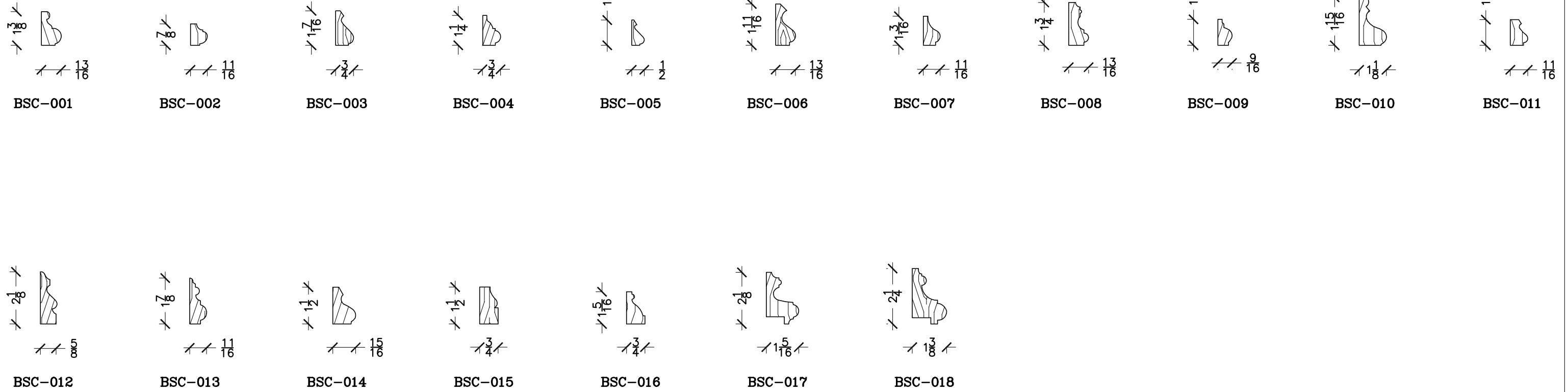

TRIM PROFILES

DATE 00/00/00	SCALE 3" = 1'-0"	DRAWN BY WW
------------------	---------------------	----------------

K & L WOODWORKING, INC.
440 N. 4TH STREET READING, PA 19601

SHEET DESCRIPTION TRIM PROFILES	SHEET NO. CS-5
------------------------------------	-------------------

BASE BOARD

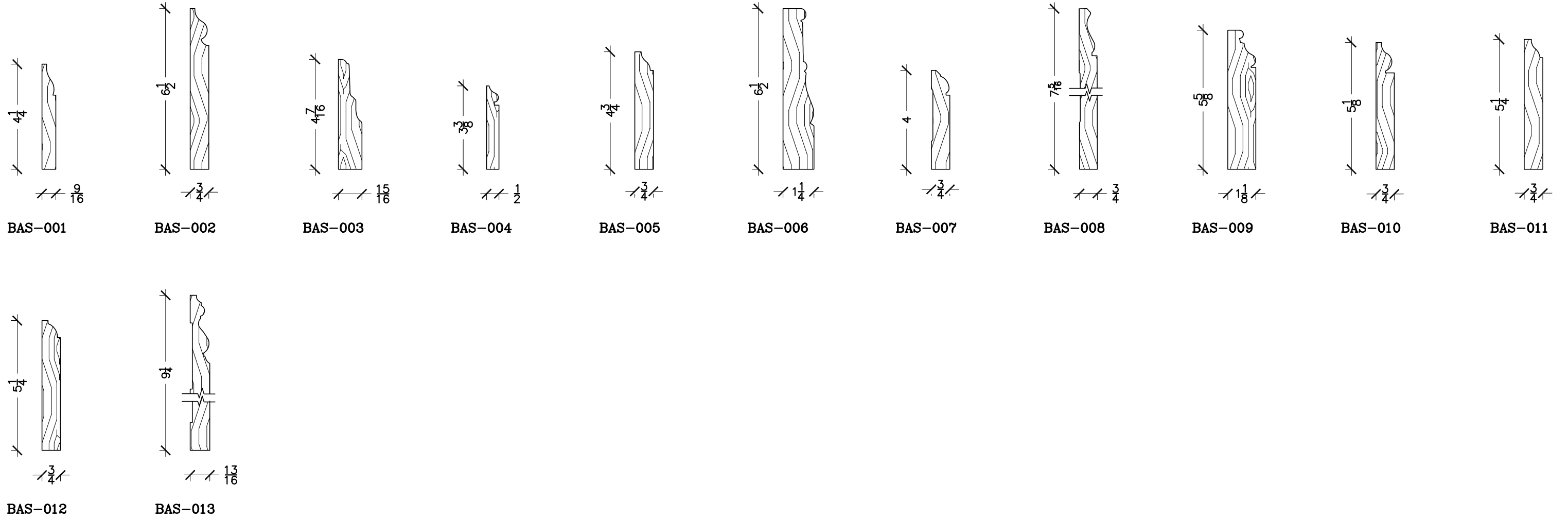

TRIM PROFILES

DATE 00/00/00	SCALE 3" = 1'-0"	DRAWN BY WW
K & L WOODWORKING, INC. 440 N. 4TH STREET READING, PA 19601		
SHEET DESCRIPTION TRIM PROFILES		SHEET NO. CS-6

BAR RAIL

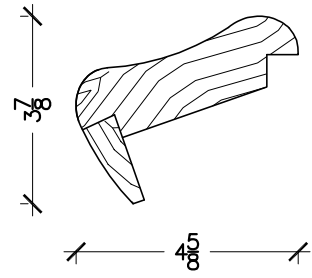

BAR-22A

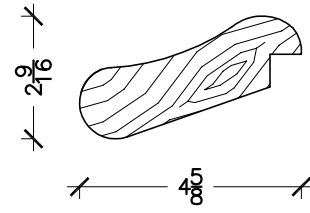

BAR-22D

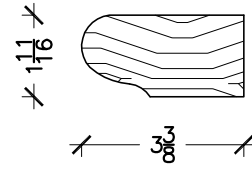

BAR-23

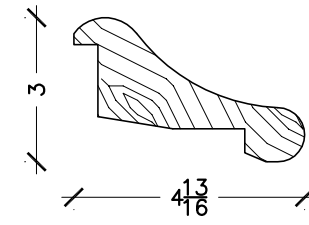

BAR-24

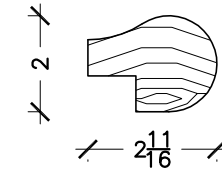

BAR-25

TRIM PROFILES

DATE 00/00/00	SCALE 3" = 1'-0"	DRAWN BY WW
------------------	---------------------	----------------

K & L WOODWORKING, INC.
440 N. 4TH STREET READING, PA 19601

SHEET DESCRIPTION TRIM PROFILES	SHEET NO. CS-7
------------------------------------	-------------------

HAND RAIL

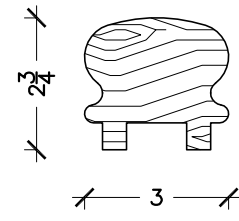

HR-001

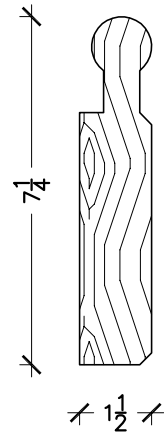

HR-002

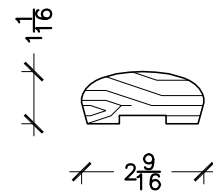

HR-003

TRIM PROFILES

DATE 00/00/00	SCALE 3" = 1'-0"	DRAWN BY WW
------------------	---------------------	----------------

K & L WOODWORKING, INC.
440 N. 4TH STREET READING, PA 19601

SHEET DESCRIPTION TRIM PROFILES	SHEET NO. CS-8
------------------------------------	-------------------

WALL CAP

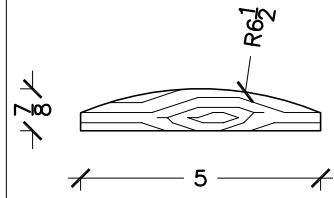

CAP-001

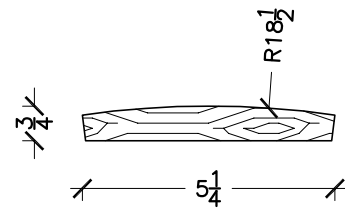

CAP-002

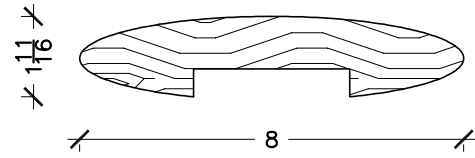

CAP-003

TRIM PROFILES

DATE 00/00/00	SCALE 3" = 1'-0"	DRAWN BY WW
------------------	---------------------	----------------

K & L WOODWORKING, INC.
440 N. 4TH STREET READING, PA 19601

SHEET DESCRIPTION
TRIM PROFILES

SHEET NO.
CS-9

FACIA

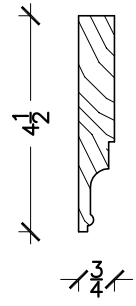

F-001

TRIM PROFILES

DATE 00/00/00	SCALE 3" = 1'-0"	DRAWN BY WW
------------------	---------------------	----------------

K & L WOODWORKING, INC.
440 N. 4TH STREET READING, PA 19601

SHEET DESCRIPTION TRIM PROFILES	SHEET NO. CS-10
------------------------------------	--------------------

ROUND

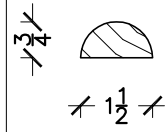

RND-001

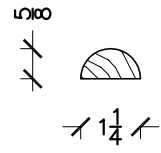

RND-002

TRIM PROFILES

DATE 00/00/00	SCALE 3" = 1'-0"	DRAWN BY WW
------------------	---------------------	----------------

K & L WOODWORKING, INC.
440 N. 4TH STREET READING, PA 19601

SHEET DESCRIPTION TRIM PROFILES	SHEET NO. CS-11
------------------------------------	--------------------